

JetNet 5728G-24P

Industrial Rackmount 24+4G Managed High Power IEEE802.3at PoE Switch w/ 24-port PoE



- 24 10/100 BaseTX and 4 Gigabit uplink ports
- 24 ports support both 15.4W IEEE 802.3af and the latest 30W high power IEEE 802.3at, including 2-event and LLDP classification
- Total power budget is 540W in DC power mode and 240W in AC power mode by IEEE 802.3at with maximum 30W per port
- Flexible-bandwidth and long-distance data transmission by SFP transceivers
- LPLD for reliable PoE connection through Active Powered Device status detection and auto reset function
- Non-Blocking backplane, 16K MAC table for wire speed bidirectional switching
- IEEE 1588 PTP compliance for precise time synchronization
- Korenix patented MSR for aggregating up to 12 x 100Mbps plus 2 Gigabit rings
- Supports up to 9,216 bytes Jumbo Frame for secured large file transmission
- IEEE 802.1AB LLDP and optional Korenix NMS software for auto-topology and large network group management
- IGMP Query v1/v2 & Snooping v1/v2/v3 for advanced multicast filtering
- Up to 256 VLAN traffic isolation
- Advanced network management features support SNMP, RMON
- Supports DHCP client/server, DHCP Option 82 for automatic IP configuration
- Dual redundant low voltage range: 48VDC(46~57VDC) and High voltage range: 90~264VAC or 127~370VDC
- IP31 rugged metal case with great heat dispersion

Overview

JetNet 5728G-24P series is a rackmount High-Port Density and Gigabit Managed Industrial 24-port PoE switch, designed exclusively for highly critical and large-scale PoE applications such as real time IP video surveillance with high resolution quality and the evolving wireless communication systems such as Wimax and 802.11 a/b/g/n Access Points.

All of the 24 Fast Ethernet PoE injector ports of the switch can deliver 15.4W by IEEE 802.3af or 30W by the latest High Power PoE IEEE 802.3at standard. The switch generates up to 540W total power budget in DC power mode and 240W in AC power input mode for upgrading the existing video network infrastructure to a powerful surveillance network.

The 4 Gigabit Ethernet ports provide high speed uplink to connect with higher level backbone switches. With the Korenix patented MSR™ network redundancy technology, the switches can aggregate up to 12 Fast Ethernet and 2 gigabit rings while providing high quality data transmission with less than 10ms network recovery time. Furthermore, to ensure the traffic switching without

data loss and blocking, the JetNet 5728G-24P provides backplane with the integrated non-blocking switching function.

JetNet 5728G-24P incorporates LLDP function and perfectly works with the Korenix patented Korenix NMS for allowing administrators to automatically discover devices and efficiently manage the industrial network performance in large scale surveillance networks. To further ensure the non-stop power delivery, JetNet 5728G-24P supports dual 48VDC power inputs and provides alarm relay output signaling function. For high voltage requiring applications the PoE switch provides extra 90~264VAC or 127~370VDC power supply capability.

With the advanced Layer2 management features including IGMP Query/Snooping, DHCP, 256 VLAN, QoS, LACP, LPLD, etc. and the corrosion resistant robust design, JetNet 5728G-24P highly outstands from other PoE switches and becomes the revolutionary solution for industrial surveillance applications.

Driving the IP Surveillance / Wireless PoE market

Since the ratification of the PoE standard in 2003, the Power over Ethernet technology becomes a trend; more devices adopt PD technology to obtain power through Ethernet cable eliminating the need of running separate power wirings to a remote device. In this regard, the IEEE 802.3af PoE standard with 15.4W power budget already satisfies the power needs of most applications, such as 802.11 a/b /g /n wireless AP for Hot-Spots, Airport Terminations etc. However, it cannot satisfy the power needs of high-end demanding applications, such as WiMAX, IP DOM Cameras, which require greater than the 15.4W power.

The JetNet 5728G-24P comes with the new PSE solution, compliant with both IEEE 802.3af and IEEE 802.3at high power PoE standards. All 24 PoE ports support IEEE 802.3at PoE plus standard and can deliver 30 watts power per port and up to 540W per unit in DC power mode (at 65°C) and 240W per unit in AC power



mode (at 50°C) to outdoor PTZ IP cameras with direction control for cross-street monitoring, or WiMAX systems for internet access in train stations, airports or Hot-spots. The additional four Gigabit ports provide more resilient and redundancy for users while forming ring networks and delivering increased bandwidth to the central network.

4 Powering Modes for Flexible Applications

In WiMax systems, Wireless APs, and high-end PoE applications, there are various types of PDs, for instance, IEEE 802.3af, IEEE 802.3at 2-event, IEEE 802.3at LLDP, and non-standard type. To meet all of the PD types in the industry, JetNet 5728G-24P is the world's first rackmount High Power PoE switch, designed with 4 powering

modes, including IEEE 802.3af mode, IEEE 802.3at 2-event mode, IEEE 802.3at LLDP classification mode as well as forced powering mode. As a result, it becomes highly competitive in the market while being flexibly used to deliver power for different PoE-enabled devices in various applications.

IEEE 802.3at 2-event Power over Ethernet

JetPoE series rackmount switches feature IEEE 802.3at High Power PoE 2-event classification method into the system for the PoE power budget management between PSE and PD devices. The IEEE 802.3at 2-event mode allows PD devices request up to 30W power from the switches through the PoE chip behavior without the need of implementing additional software, such as LLDP at both PD and PSE. As a result, the switches are capable to efficiently power High-end PoE-enabled devices in an easy way without any software configurations.

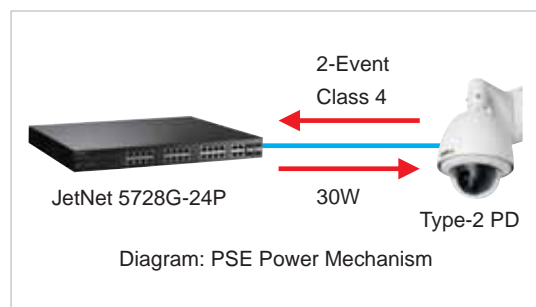

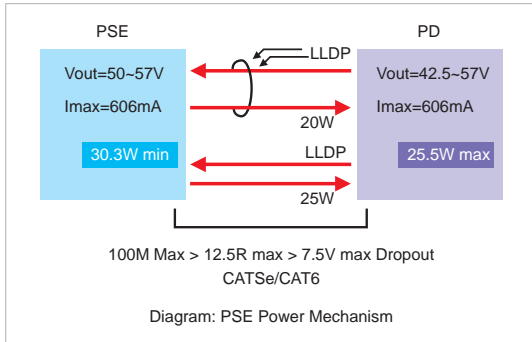

IEEE 802.3at LLDP Power over Ethernet

JetNet 5728G-24P series implements the Link Layer Discovery Protocol (LLDP) PoE into the system for efficient power budget negotiation between PSE and PD devices. The LLDP packet provides smart power budget control behavior to fulfill the needs of higher end setups requiring exact high power delivery. By using the ongoing dynamic re-negotiation function of the IEEE802.3at LLDP PoE, the JetNet 5728G-24P can perform more intelligently by dynamically reallocating power to the PDs.

IEEE 802.3at 3rd Party PSE Conformance Tested

The JetNet 5728G-24P has been tested by Korenix and 3rd party organization for the conformance and inter-operability of its new IEEE 802.3at 2-event and

IEEE 802.3at LLDP technologies, thus, guaranteeing the intelligent power delivery, high performance functionality and reliability of the devices.

Reliable Power Feeding Mechanisms

The JetNet 5728G-24P is offered with dual 48VDC power inputs for providing true network redundancy. An alarm relay output signals when a power input fails or other critical events occur.

To ensure reliable power delivery, other advanced PoE power management features include individual port status monitoring, emergency power management (3 power supply indication inputs for quick shutdown of ports according to pre-defined priority table in cases where power supply failure occurs) and voltage/current monitoring and regulation. Power management allows the JetNet 5728G-24P series to determine the exact power draw per port and to balance each port PoE power output accordingly. This, in turn, allows the switch to

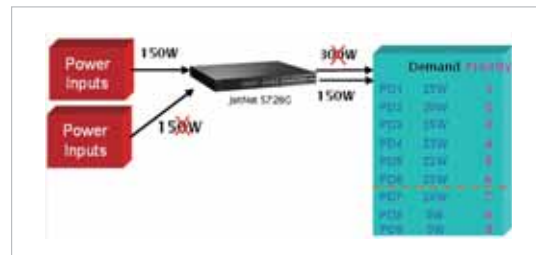

power higher and lower wattage devices according to user-definable parameters such as maximum available power, port priority (critical, high, low), and maximum allowable power per port.

High Port Density and Gigabit Capability

With 24 10/100 Mbps ports and 4 RJ-45/SFP combo ports JetNet 5728G-24P series can connect to servers or Gigabit-speed backbone to provide quick and reliable delivery of large multimedia, image and video files in a non-stop network. The 4 shielded RJ-45 ports

automatically negotiate to the highest speed, whereas the 4 hot-swappable SFP GBIC slots provide optional copper and fiber-based gigabit media connectivity for flexible bandwidth and longer distance transmission.

- Industrial Intelligent NMS
- Rackmount PoE Plus Switch
- Industrial PoE Plus Switch
- Industrial 12-24V PoE Switch
- Industrial PoE Switch
- Rackmount L3/L2 Switch
- Gigabit Managed Switch
- Managed Ethernet Switch
- Entry-level Switch
- Wireless Outdoor AP
- Embedded PoE/Router Computer (LINUX)
- Industrial Communication Computer (WIN/LINUX)
- Ethernet/PoE/ Serial Board
- Ethernet I/O Server
- Media Converter
- Serial Device Server
- SFP Module
- Din Rail Power Supply

Up to 9KBytes Jumbo Frame

The typical Ethernet frame ranges from 64 to 1518 bytes, which is only sufficient for general usage. Contrary, in large scale surveillance networks, where users need to transmit large video streams, the files may be divided into many small size packets. While the transmitting

speed becomes slow, 9KBytes Jumbo frame can solve the issue.

Korenix JetNet 5728G-24P supports Jumbo Frame to enhance the network communication while allowing users to easily transmit up to 9K Jumbo Frame packet.

Multiple Super Ring (MSR™) Aggregation Capability

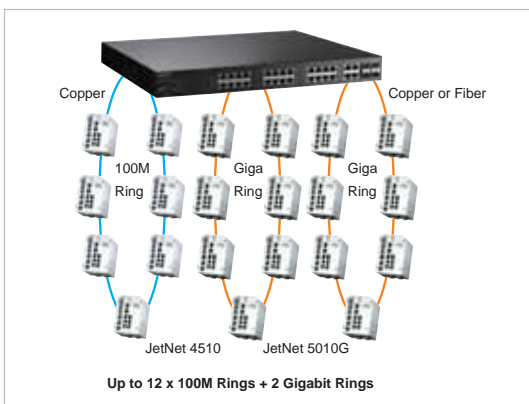

The JetNet 5728G-24P series supports the new generation ring technology – MSR™ which includes various new technologies for redundancy applications and structures of different networks. The PoE switch allows to aggregate up to 14 Rapid Super Rings, including 12 Fast Ethernet plus 2 gigabit Ethernet Rings. With the MSR™ technology, a node can be configured to multiple rings with the failover time in as little as 10ms, and zero-second of restoration time.

LPLD for Smart Powered Device Alive-Check

JetNet 5728G-24P can be configured by Korenix patented PoE “Link Partner Line Detect” technology to guarantee the reliable connection of PD devices through easy monitoring of their real-time status.

Once the keep-alive checking detects PD failure, it resets the PoE port to bring the PD back to a working state. This greatly enhances the system reliability while minimizing the maintenance time and cost.

Auto Topology Discovery & Efficient Management

JetNet 5728G-24P supports topology discovery or LLDP (IEEE 802.1AB Link Layer Discovery Protocol) function that can help users to discover multi-vendor’s network devices on the same segment by an NMS system, which support LLDP function. With LLDP function, NMS can easily maintain the topology map, display port ID, port description, system description, VLAN ID, etc.. Once a link failure happens, the topology changed events are updated to the NMS to help users easily maintain the network system. Besides the SNMP and LLDP protocols, JetNet 5728G-24P efficiently works with the Korenix patented Korenix NMS, which in addition to the auto-topology discovery, also delivers MSR™ group management, group IP assignment, group firmware upgrade, group configuration file backup/ restore, SNMP

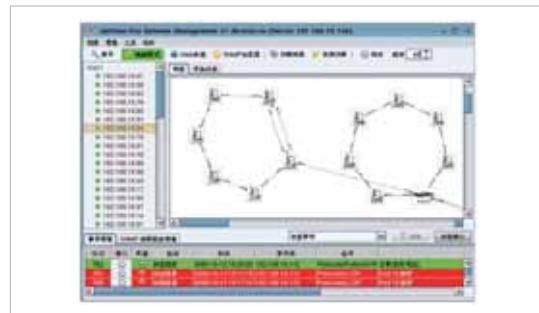

MIB Browser /compiler, etc.

The user-friendly software allows administrators to discover devices automatically and efficiently manage the performance of the large-scale industrial surveillance networks.

Outstanding Management and Enhanced Security

JetNet 5728G-24P provides various software features for ensuring high-quality performance, bandwidth aggregation and efficient video stream transmission in industrial surveillance networks.

The network optimization can be achieved by the JetNet 5728G-24P switches' DHCP option 82, QoS, 256 VLAN groups, IGMP Query/Snooping, GMRP, LACP link

aggregation (802.3ad), ACL (Access Control List), PoE scheduling and many other advanced management and security features. System administrators can benefit from its rich interface for remotely managing and configuring devices via Korenix View, Korenix NMS (Korenix's advanced management utility), Web browser, SNMP, Telnet etc.

JetNet 5728G-24P Appearance

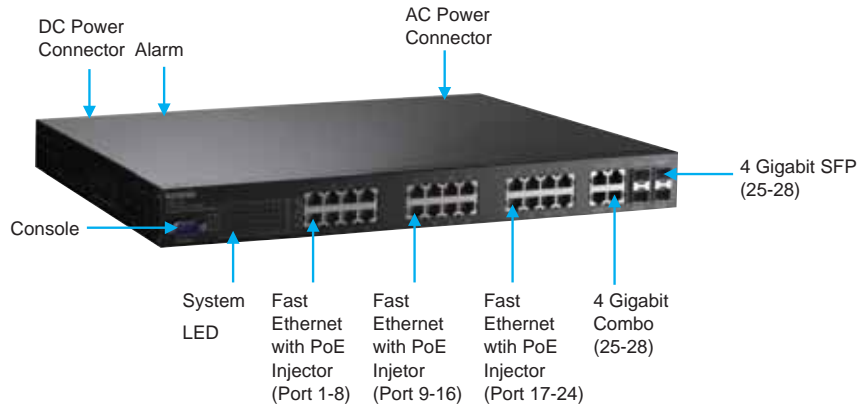

Dimensions (Unit = mm)

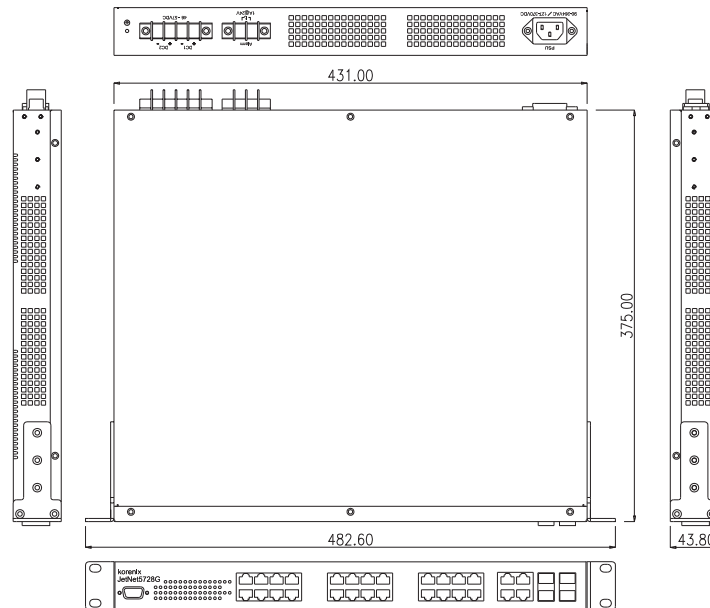

- Industrial Intelligent NMS
- Rackmount PoE Plus Switch**
- Industrial PoE Plus Switch
- Industrial 12-24V PoE Switch
- Industrial PoE Switch
- Rackmount L3/L2 Switch
- Gigabit Managed Switch
- Managed Ethernet Switch
- Entry-level Switch
- Wireless Outdoor AP
- Embedded PoE/Router Computer (LINUX)
- Industrial Communication Computer (WIN/LINUX)
- Ethernet/PoE/Serial Board
- Ethernet I/O Server
- Media Converter
- Serial Device Server
- SFP Module
- Din Rail Power Supply

Specification

Technology

Standard:

IEEE 802.3 10Base-T Ethernet
 IEEE 802.3u 100Base-TX Fast Ethernet
 IEEE 802.3ab 1000Base-TX
 IEEE 802.3z Gigabit Ethernet Fiber
 IEEE 802.3x Flow Control and back pressure
 IEEE 802.3af Power Over Ethernet (PoE)
 IEEE 802.3at Power Over Ethernet Plus (PoE Plus)
 IEEE 802.1p Class of Service
 IEEE 802.1Q VLAN
 IEEE 802.1P GMRP
 IEEE 802.1d Spanning Tree Protocol
 IEEE 802.1D-2004 Rapid Spanning Tree Protocol (RSTP)
 IEEE 802.1s Multiple Spanning Tree Protocol (MSTP)
 IEEE802.3ad Link Aggregation Control Protocol (LACP)
 IEEE802.1x Port based Network Access Control
 IEEE802.1AB Link Layer Discovery Protocol
 IEEE1588 Precision Time Protocol

Performance

Switch Technology:

Store and Forward Technology, 12.8Gbps Switch Fabric.

System Throughput: 14,880pps for 10M Ethernet, 148,800pps for 100M Fast Ethernet, 1,488,100 for Gigabit Ethernet

Transfer packet size: Typical: 64 bytes to 1546 bytes

Jumbo Frame Enabled: Up to 9,216bytes

MAC Address: 16K

Packet Buffer: 32Mbits

PoE Technology: End-Span wiring architecture, fully IEEE802.3af-2003 compliant, and support IEEE802.3at, including 2-event and LLDP classification

PoE Pin Assignments: RX/V-(1, 2) and TX/V+(3, 6)

Management

Configuration: Cisco-Like CLI, Telnet, Korenix NMS, Web, SSL, SSH, SNMP v1/v2c/v3, RMON

LLDP: Link Layer Discovery Protocol for NMS automated topology discovery (ex. Korenix NMS)

SNMP Trap: SNMP v1/v2c Traps.

SNMP MIB: MIB-II, Bridge MIB, Ethernet-like MIB, VLAN MIB, SNMP MIB, PoE MIB, LLDP MIB, RMON MIB, Trap MIB, and Private MIB

NTP: Network Time Protocol to synchronize time

Port Mirroring: Online traffic monitoring

Port Trunk: Static Trunk and 802.3ad LACP, Up to 8 Trunk Group, 8 ports per trunk

Rate Control: Ingress filtering for Broadcast, Multicast, Unknown DA or All packets, step by 64kbps.

VLAN: IEEE802.1Q VLAN, GVRP. Up to 256 VLANs

Quality of Service: 8 priority queues per port, IEEE802.1p COS and Layer 3 TOS/DiffServ

IGMP Snooping: IGMP Snooping v1/v2/v3 for multicast filtering and IGMP Query v1/v2

GMRP: GARP Multicast Registration Protocol

IEEE 1588 PTP: Precision Time Protocol for precise time synchronization of networks

Port Security: Assign authorized MAC to specific port

802.1x: Port based Network Access Control

Access Control List (ACL): L2~L4 access control lists

DHCP: Supports DHCP Client/Server & DHCP Option 82

E-mail Warning: Automatic warning by pre-defined events

Syslog: Supports both local mode and server mode

Network Redundancy

Rapid Spanning Tree Protocol: IEEE802.1D-2004 RSTP. Compatible with STP.

Multiple Super Ring (MSR™): New generation Korenix Ring Redundancy Technology, including Rapid Super Ring, Rapid Dual Homing, TrunkRing, and MultiRing.

Rapid Super Ring (RSR™): Provide failover time less than 10 ms and seamless restoration at full load

Rapid Dual Homing (RDH™): Multiple uplink paths to one or multiple upper switch

TrunkRing™: Increase the ring bandwidth and redundancy

MultiRing™: Multiple ring connections. Up to 12 100Mbps rings and 2 Gbps rings in one JetNet 5728G.

LPLD™: Auto-detect Powered Device status for device auto-reset

PoE Schedule Management: Each PoE port can be activated and powered scheduling with different rules.

Weekly schedule on hourly basis is supported

Advanced PoE Power Management: Individual port status monitoring, emergency power management, voltage/current monitoring and regulation

Interface

Number of Ports:

10/100Base-TX: 24 x RJ-45 with 24 PoE injector

10/100/1000Base-TX: 4 x RJ-45, combo with SFP

1000Base-X: 4 x SFP with Hot Swappable

Cables:

10Base-T: 2-pair UTP/STP Cat. 3, 4, 5 cable (100m)

100 Base-TX: 2/4-pair UTP/STP Cat. 5 cable (100m)

1000 Base-T: 4-pair UTP/STP Cat. 5 cable (100m)

MSR status LED:

1. MSR in Normal State (Lit Green)

2. MSR in Abnormal State (Lit Amber)

3. MSR function not active (Not Lit)

4. Incorrect configuration of MSR, ex. ring not connected to ring port (Flashes Green)

5. The break has been detected to be local to one of the ports (Flashes Amber)

PoE LED:

802.3af mode: Detection/Powering (Green)

802.3at mode: Detection/Powering (Blue)

Port LED:

10/100 RJ-45: Link/Activity (Lit Green/Flashes Green)

Gigabit Copper/SFP: Link/Activity (Lit Green/Flashes Green)

Diagnostic LED:

PSU/DC Power (Green), RDY (Green), Alarm (Red)

RS232 Console: RJ-45 Connector, Pin3: TxD, Pin6: RxD, Pin5:GND

Power Connector: 1 Standard 3-pronged AC plug + 4 pin DC Terminal Block

Relay Alarm: 1 set of relay output with current carrying capability of 1A@24V

Alarm Events: Power (PSU, DC1, DC2) failure, port failure, ping failure, login failure, RSR topology change

Power Requirements

Power Consumption without the PD Loading: 28 Watts Max
 PSU: 90-264VAC/127-370VDC, 300W
 DC1/DC2: 48VDC (46-57VDC), redundant dual inputs
Overload Current Protection: Present
Reverse Polarity Protection: Present
PoE Power Output IEEE 802.3at: 50-57VDC, 0.6A
PoE Power Output IEEE 802.3af: 44-57VDC, 0.35A
PoE Protection: over-temp, over-current, over/under-voltage & transient

Mechanical

Installation: 19-inch, 1U Rack Mount
Casing: IP31 protection, Metal case
Dimension: 43.8mm(H) x 431mm (W) x 375mm (D)
Weight: appr. 5 kg

Environmental

Operating Temperature: -25 ~ 65°C (fanless)
Operating Humidity: 5% ~ 95% (non-condensing)
Storage Temperature: -40 ~ 85°C
Hi-Pot: 1.5KV for ports and power

Regulatory Approvals

EMI: FCC Class A, CE/EN55022. Class A
EMS:
 EN61000-4-2 (ESD), level 3
 EN61000-4-3 (RS), level 3
 EN61000-4-4 (EFT), level 3
 EN61000-4-5 (Surge), level 3
 EN61000-4-6 (CS), level 3
 EN61000-4-8
 EN61000-4-11
Traffic Control: NEMA TS2 (Pending)
Maritime: DNV (Pending), GL (Pending)
Safety: UL, cUL, EN60950 (Applying)
Shock: IEC60068-2-27
Vibration: IEC60068-2-6
Free Fall: IEC60068-2-32
MTBF: Above 200,000 Hours, MIL-HDBK-217F GB standard
Warranty: 5 years

Ordering Information

- **JetNet 5728G-24P:** Industrial Rackmount 24+4G Gigabit Managed High Power IEEE 802.3at PoE Switch with 24-port PoE JetNet 5728G-24P (without SFP transceivers), Rack Mount Kit, Quick Installation Guide, Document CD

Optional Accessories

SFP Transceiver

- Gigabit Multi-Mode SFP Transceiver
- Gigabit Single-Mode SFP Transceiver
- Gigabit BIDI/WDM Single-Mode SFP Transceiver

Power Supply

- SDR-480-48: Industrial DC48V Power Supply, 90~264VAC/127~370VDC power input, -25~70°C

Industrial
Intelligent
NMS

**Rackmount
PoE Plus
Switch**

Industrial
PoE Plus
Switch

Industrial
12-24V
PoE Switch

Industrial
PoE Switch

Rackmount
L3/L2 Switch

Gigabit
Managed
Switch

Managed
Ethernet
Switch

Entry-level
Switch

Wireless
Outdoor AP

Embedded
PoE/Router
Computer
(LINUX)

Industrial
Communication
Computer
(WIN/LINUX)

Ethernet/PoE/
Serial Board

Ethernet
I/O Server

Media
Converter

Serial Device
Server

SFP Module

Din Rail
Power Supply